

3-JAW CONCENTRIC GRIPPERS

SERIES GED5000

▶ PRODUCT ADVANTAGES



IO-Link

“ALL in ONE”

- ▶ Approximately the same gripping force as a comparable pneumatic gripper
- ▶ Self locking mechanism in case of power drop
- ▶ Same connection hole patterns as a comparable pneumatic gripper
- ▶ Plug and play – single-cable solution, supports incredibly easy control using I/O signals or IO-Link
- ▶ Integrated ACM control module - option of configuring gripping force, travel time and switching points
- ▶ Protected from corrosion and sealed in accordance with IP64
- ▶ Brushless DC motor – up to 30 million cycles without maintenance



reddot design award winner 2018

▶ SERIES CHARACTERISTICS

Installation size	Variants	
GED50XX	IL-00	IO-00
IO-Link	•	
Digital I/O		•
30 million maintenance-free cycles (max.)	•	•
Integrated sensing	•	•
Gripping force adjustable	•	•
Self locking mechanism	•	•
Protected against corrosion	•	•
Purged air	•	•
IP64	•	•

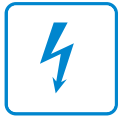

► BENEFITS IN DETAIL

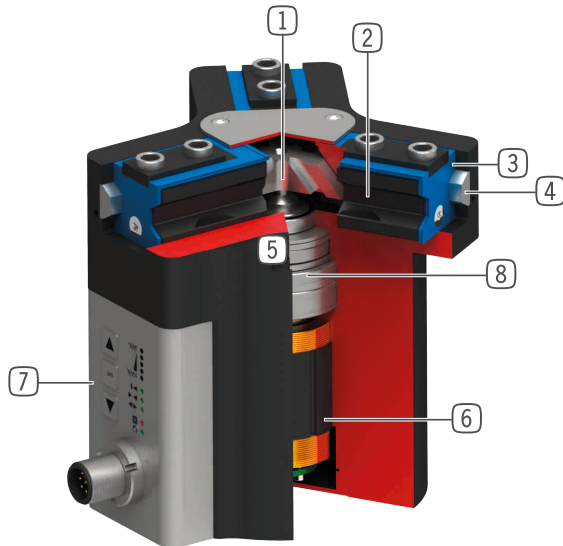

- ① **Wedge hook mechanism**
 - high forces and moments capacity
 - Synchronized gripper jaw movement
- ② **Gripper jaw**
 - Gripper fingers mounted using removable centering sleeves
 - Lubricated for life via incorporated lubrication slots
- ③ **Dual lip seal**
 - Enables IP64
 - Prevents grease from being squeezed out, increasing service life
- ④ **Steel Linear Guide**
 - Steel in steel guide
 - Enables use of extremely long gripper fingers
- ⑤ **Mounting and positioning**
 - Alternatively, on several sides for customized mounting
 - Pneumatic and electrical versions identical apart from height
- ⑥ **BLDC motor**
 - wear-resistant brushless DC motor
- ⑦ **Advanced control module**
 - Integrated control module with single-cable solution
 - Gripping force, travel time and query programmable via the control panel on the housing
- ⑧ **Drive train**
 - Combination of trapezoidal spindle and gear
 - Durable and robust

► TECHNICAL DATA

Installation size	Stroke per jaw [mm]	Gripping force [N]	Weight [kg]	IP class
GED5006	6	540 - 960	1.09	IP64 *
GED5008	8	650 - 1150	1.66	IP64 *
GED5010	10	980 - 1520	2.33	IP64 *

*with purged air (max. 0,5 bar)

► FURTHER INFORMATION IS AVAILABLE ONLINE



All information just a click away at: www.zimmer-group.com. Find data, illustrations, 3D models and operating instructions for your installation size using the order number for your desired product. Quick, clear and always up-to-date.

3-JAW CONCENTRIC GRIPPERS

INSTALLATION SIZE GED5006

▶ PRODUCT SPECIFICATIONS



▶ Gripping force diagram

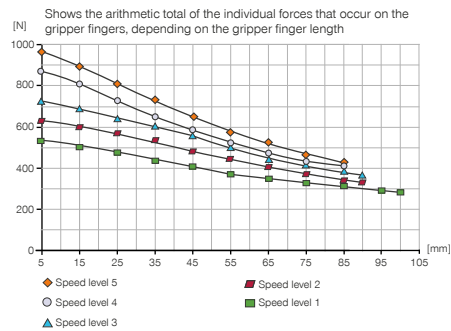

▶ Forces and moments

Displays static forces and moments that can also have an effect, besides the gripping force.



Mr [Nm]	43
Mx [Nm]	70
My [Nm]	46
Fa [N]	1250

▶ TECHNICAL DATA - BASIC VERSION

Order no.	▶ Technical data	
	GED5006IL-00-A	GED5006IO-00-A
Control	IO-Link	Digital I/O
Drive	BLDC motor	BLDC motor
Stroke per jaw [mm]	6	6
Self locking mechanism	mechanical	mechanical
Control time [s]	0.035	0.035
Permissible weight per jaw max [kg]	0.4	0.4
Length of the gripper fingers max. [mm]	100	100
Repetition accuracy +/- [mm]	0.01	0.01
Operating temperature [°C]	5 ... 50	5 ... 50
Voltage [V]	24	24
Current consumption max. [A]	5	5
Protection to IEC 60529	IP64*	IP64*
Weight [kg]	1.09	1.09

*with purged air (max. 0,5 bar)

▶ TECHNICAL DATA - MODES

Order no.	▶ Technical data - N mode	
	GED5006IL-00-A	GED5006IO-00-A
Gripping force → ← min. / max. [N]	540 / 960	540 / 960
Gripping force ↔ min. / max. [N]	540 / 960	540 / 960
Travel time → ← min. / max. [s]	0,15 / 0,22	0,15 / 0,22
Travel time ↔ min. / max. [s]	0,15 / 0,22	0,15 / 0,22

Order no.	▶ Technical data - NC mode	
	GED5006IL-00-A	GED5006IO-00-A
Gripping force → ← min. / max. [N]	540 / 960	540 / 960
Gripping force ↔ min. / max. [N]	-	-
Travel time → ← min. / max. [s]	0,15 / 0,22	0,15 / 0,22
Travel time ↔ min. / max. [s]	0,13	0,13

Order no.	▶ Technical data - NO mode	
	GED5006IL-00-A	GED5006IO-00-A
Gripping force → ← min. / max. [N]	-	-
Gripping force ↔ min. / max. [N]	540 / 960	540 / 960
Travel time → ← min. / max. [s]	0,13	0,13
Travel time ↔ min. / max. [s]	0,15 / 0,22	0,15 / 0,22

TECHNICAL DRAWINGS

- ① Gripper attachment
- ② Energy supply (M12, 8-pole)
- ③ Fixing for gripper finger
- ⑱ Air purge connection option
- ⑳ Attachment option for customer-specific fittings
- ㉔ Energy supply IO-Link (M12, 5-pole)

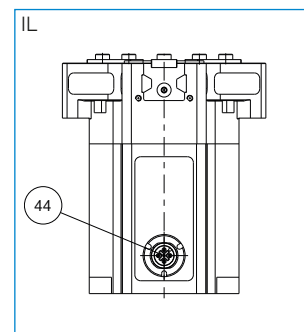
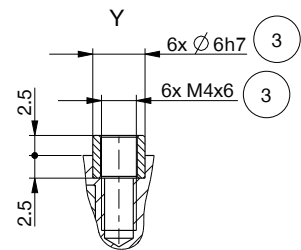
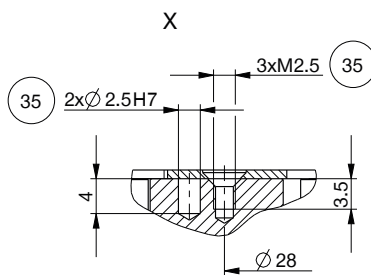
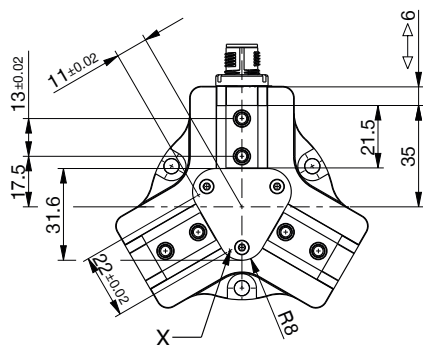
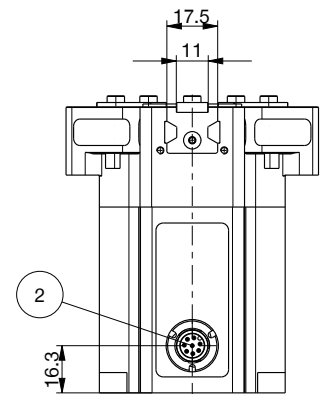
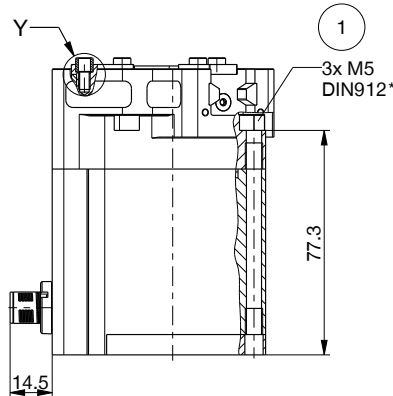
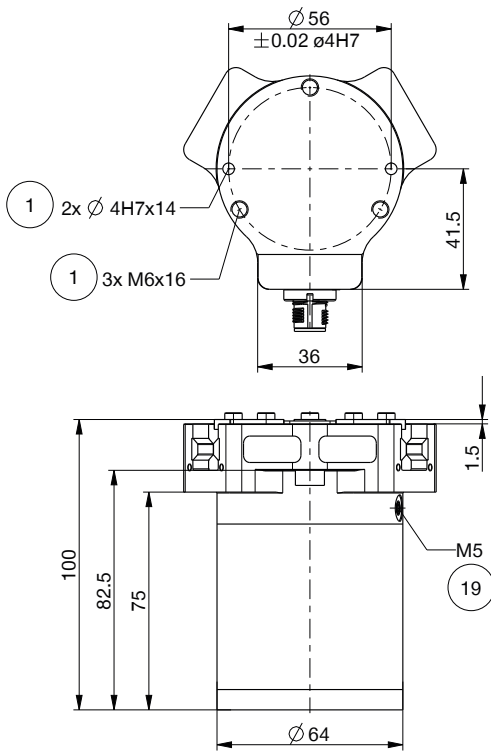

3-JAW CONCENTRIC GRIPPERS

INSTALLATION SIZE GED5006

▶ ACCESORIES



▶ INCLUDED IN DELIVERY



6 [piece]
Centering Disc

024230

▶ INFRASTRUCTURE IO-LINK

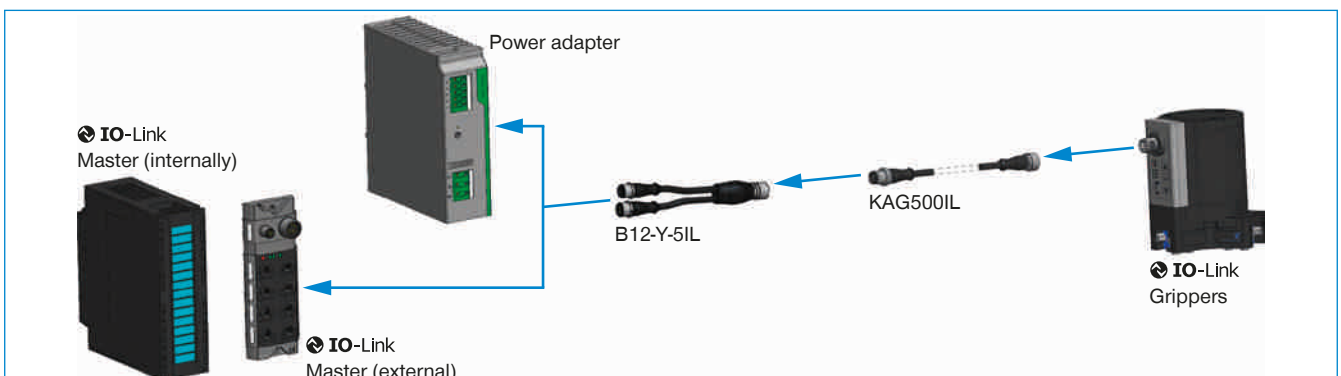

▶ RECOMMENDED ACCESSORIES



GRIPPING COMPONENTS



UB5006AL
Universal jaw aluminium



UB5006ST
Universal jaw steel



EB5006AL
Aluminum adjustment jaw



EB5006ST
Steel adjustment jaw



WB5006L
Changeable jaw, loose-part-set



WB5006F
Changeable jaw, fix-part



ADS5006-05
Pressure piece

▶ RECOMMENDED ACCESSORY GED5006IL-00-A



CONNECTIONS / OTHER

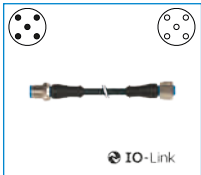

KAG500IL
Plug-in connector straight
5 m - plug, socket M12



B12-Y-5IL
Y-Plug-in Connector



SCM-C-00-00-A
Smart Communication
Module

▶ RECOMMENDED ACCESSORY GED5006IO-00-A



CONNECTIONS / OTHER

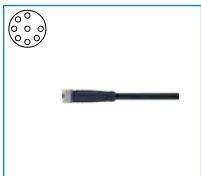

KAG1000B8
Plug-in Connector Straight
Cable 10 m - Female M12



KAW1000B8
Plug-in Connector Angled
Cable 10 m - Female M12

3-JAW CONCENTRIC GRIPPERS

SERIES GED5000 FUNCTIONAL DESCRIPTION



GRIPPING COMPONENTS

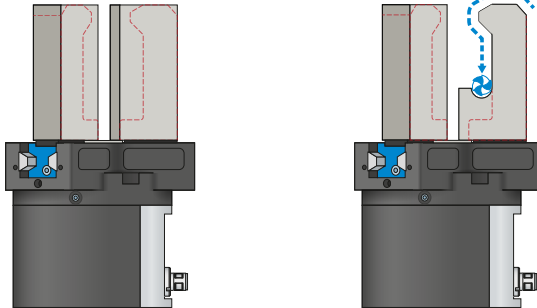

Universal jaws – UB5000

Can be used immediately or for individual reprocessing

The gripper blanks are available in aluminum (AL) and steel (ST) versions and are installed directly on the gripper using the screws in the scope of delivery. The fits for the centering sleeves are already in place for this purpose. One universal jaw is required for each gripper jaw.

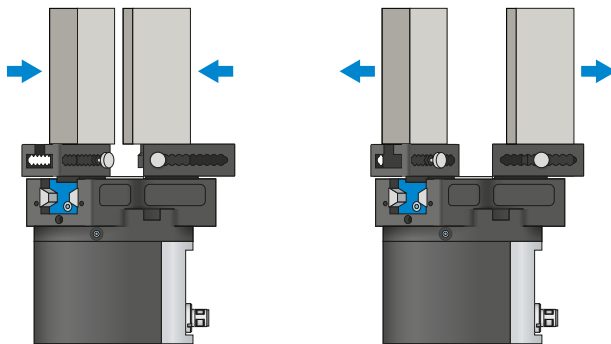

Adjustment jaws – EB5000

For tool-free adaptation of the gripper range

By manually activating the locking mechanism, which is pre-tensioned by a spring, the adjustment jaw can be moved within a grid of detent notches that has a number scale. Depending on the forces and torques that apply, the adjustment jaws are available in aluminum (AL) and steel (ST) versions. One adjustment jaw is required for each gripper jaw.

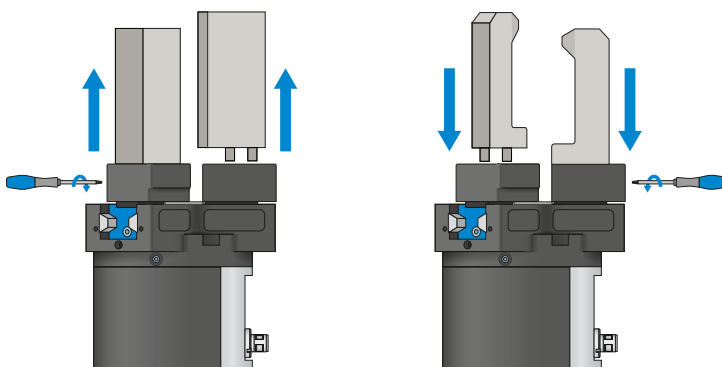

Interchangeable jaws – WB5000

Enable fast change of individual gripper fingers

For each gripper jaw, a fixed part and at least one loose part set is needed, depending on the number of gripper fingers to be changed. Manual locking via the Torx wrench included in the scope of delivery of the fixed part can take place from two sides.



THE GRIPPING COMPONENTS CAN BE COMBINED!

The gripper components listed above can be combined with each other and are compatible with the various series of the 5000 gripper family.



GRIPPING COMPONENTS

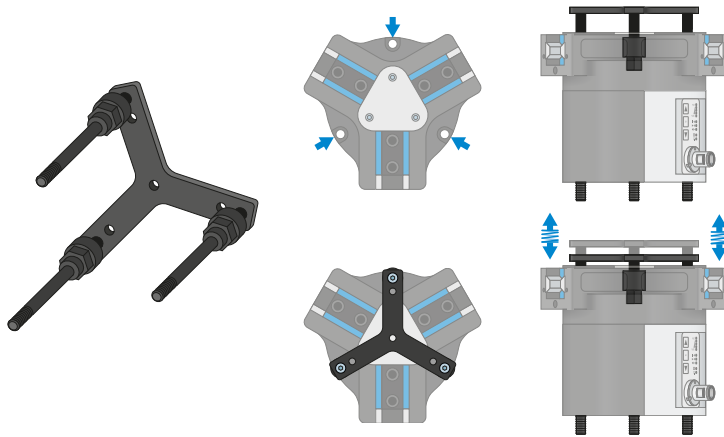

Pressure piece – ADS5000

When the gripper fingers are open, the pressure piece is used for spring-supported positioning of the workpiece against a limit stop. This greatly reduces the loads on the gripper that arise during joining.



CONNECTIONS / OTHER

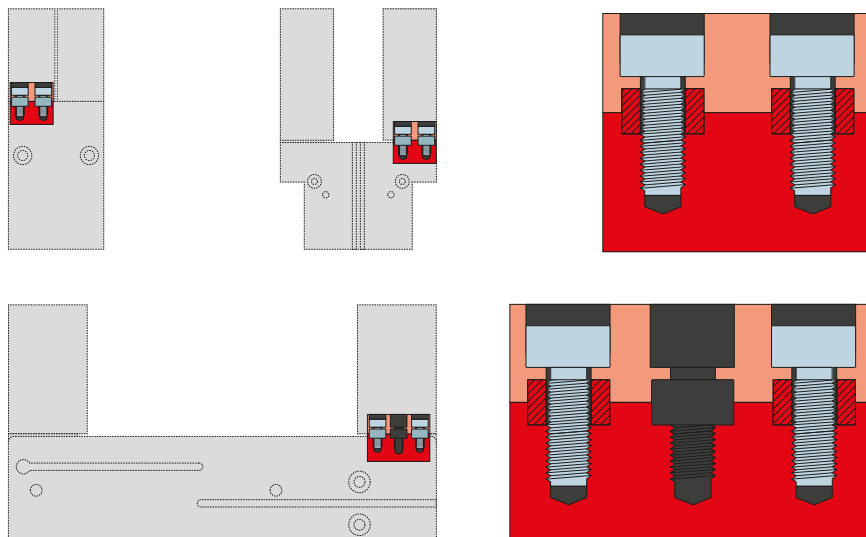

Centering sleeves

For defined position measurement of the gripper fingers

The centering sleeves are inserted into the fits of the gripper jaws to define the position of the gripper fingers. The centering sleeves are comparable to a pin connection.

SECURED CONFIGURATION EXAMPLES

GEP5000 / GED5000 SERIES

▶ GPP5000IL / GPD5000IL (IO-LINK) WIRING TO CONTROL CABINET (BECKHOFF)

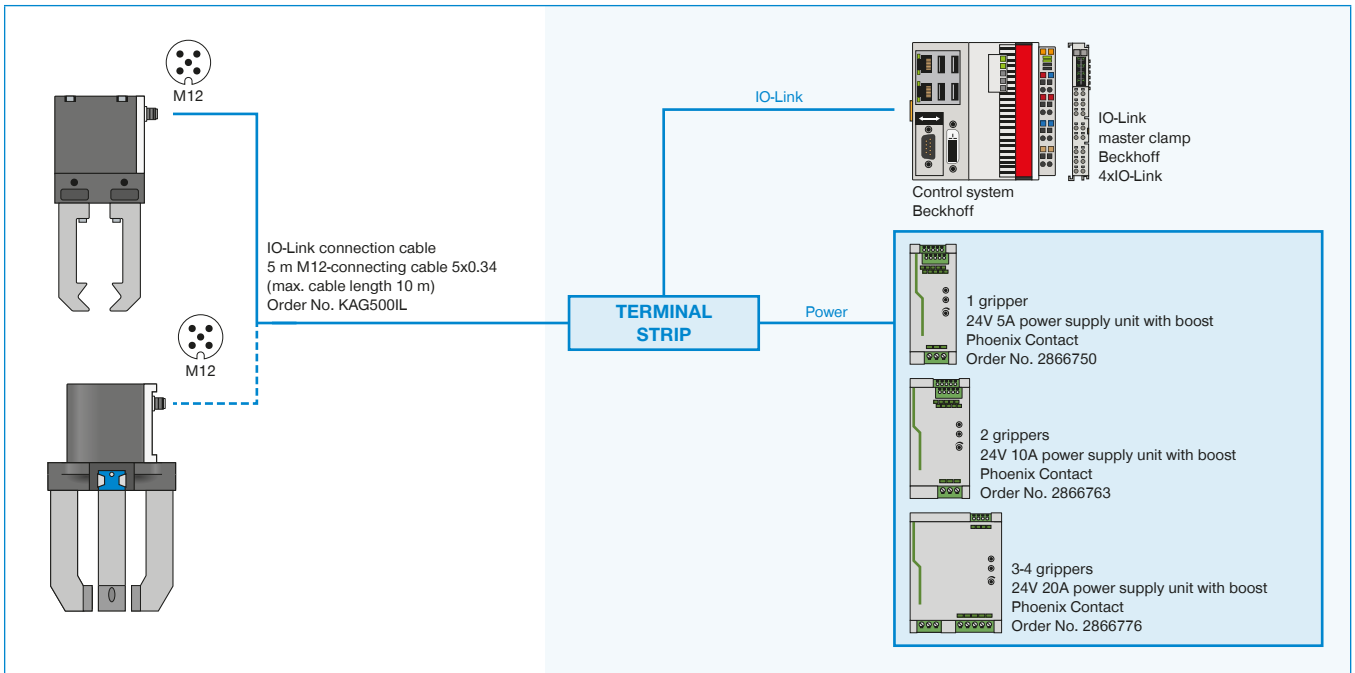

▶ GPP5000IL / GPD5000IL (IO-LINK) WIRING TO CONTROL CABINET (SIEMENS)

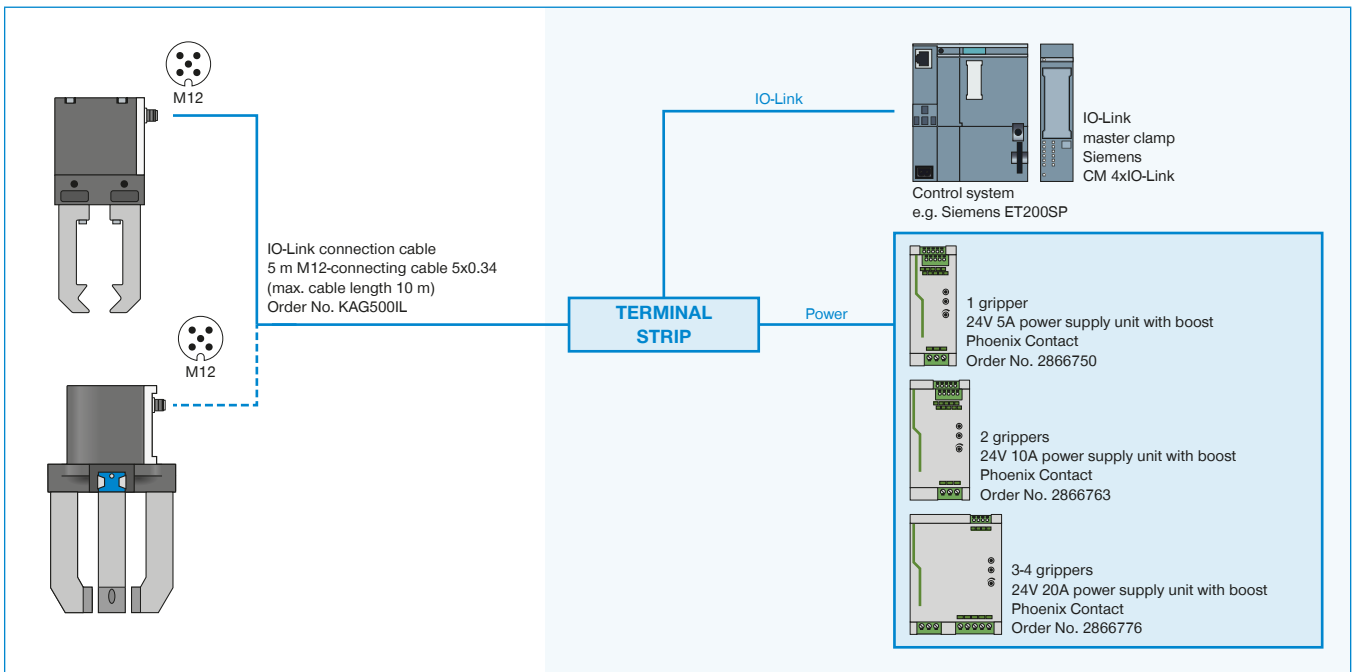

▶ GPP5000IL / GPD5000IL (IO-LINK) WIRING TO IO-LINK MASTER IP67 (BECKHOFF)

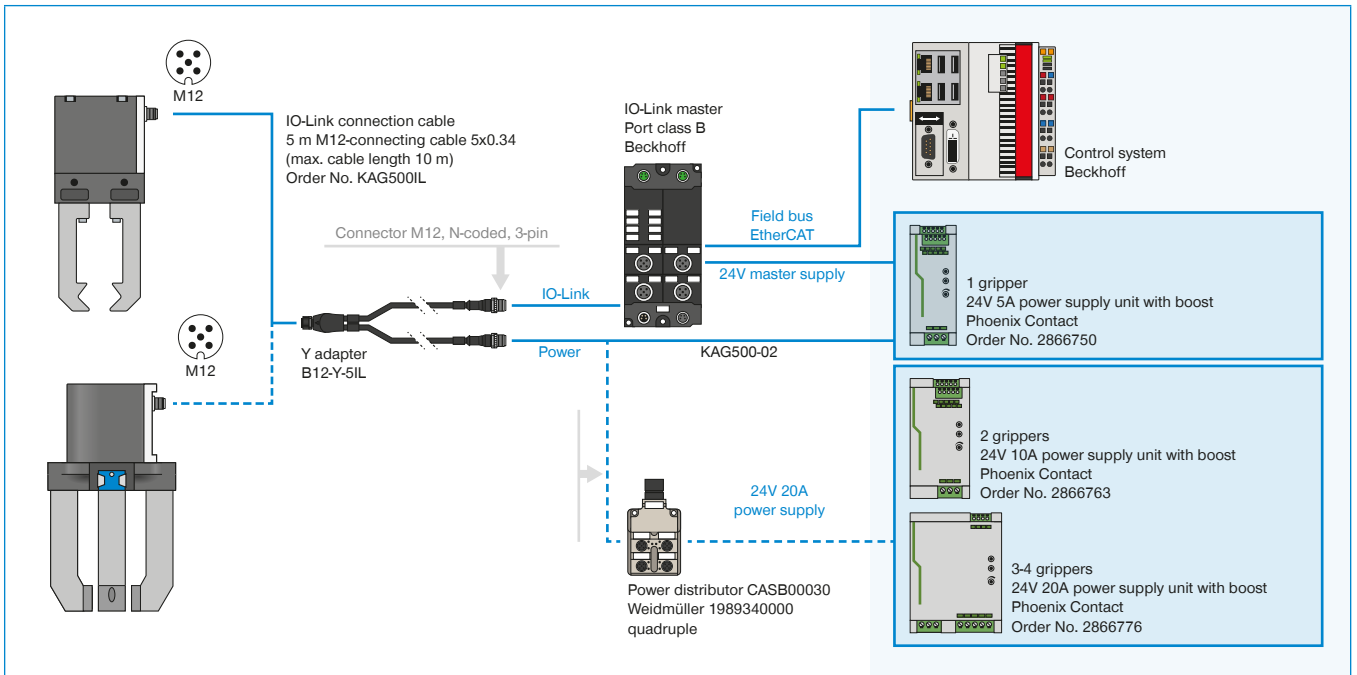

▶ GPP5000IL / GPD5000IL (IO-LINK) WIRING TO IO-LINK MASTER IP67 (BECKHOFF)

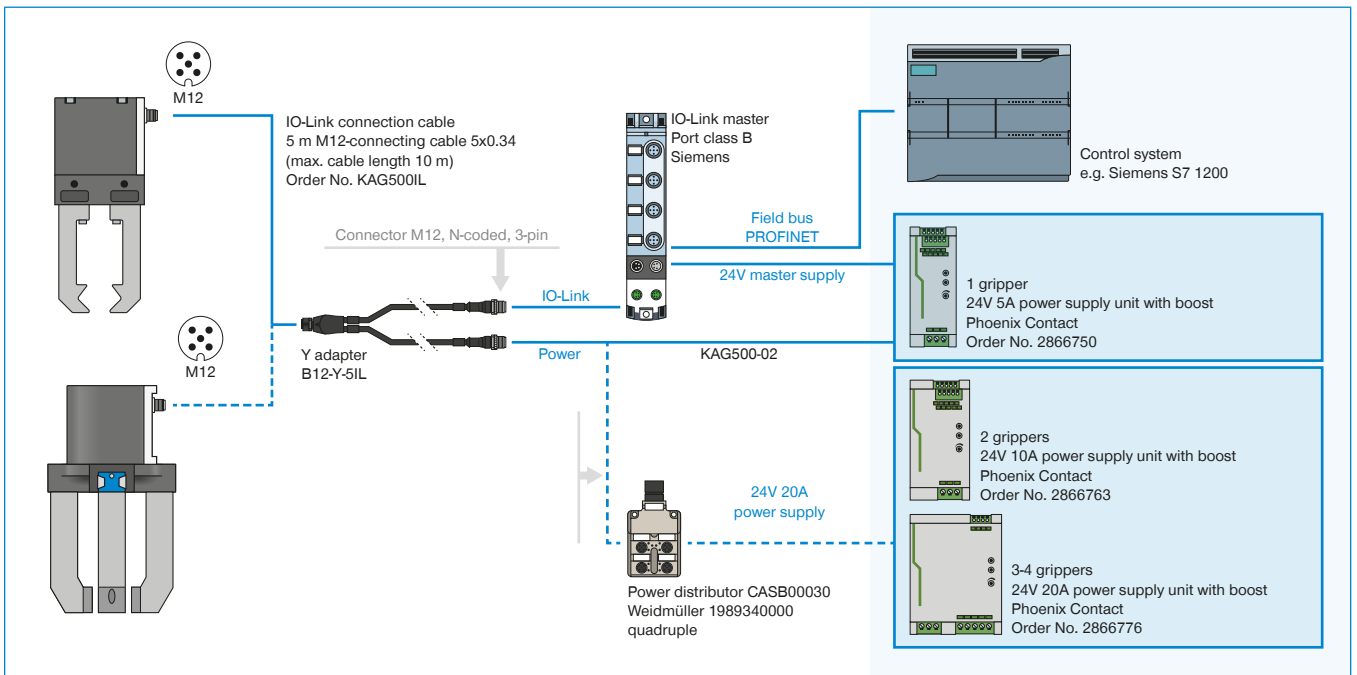

SECURED CONFIGURATION EXAMPLES

GEP5000 / GED5000 SERIES

▶ GEP5000 / GED5000 (DIGITAL IO) WIRING TO CONTROL CABINET

